





6 SERIES: 6.3+ K

<http://tiny.cc/6seriesEN>

| | | | | |
|--|--|--|--|--|
|  MAX LIFTING CAPACITY 1120 kg |  ENGINE POWER 25 hp |  SPEED 9 km/h |  FLOW RATE 50 l/min |  LIFT HEIGHT 2,92 m |
|--|--|--|--|--|

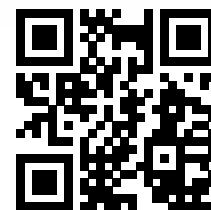

ACI
ATTACHMENT
CONTROL
INTERFACE



| Model | 6.3+ K |
|--|---------------------------------------|
| Engine | Kubota D1305 - 3 cylinder - 1261 cc. |
| Emission Standard | Stage V and Tier 4 Final |
| Power (Iso Gross) / Torque | 25 HP / 85 Nm @ 1700 rpm |
| Fuel | Diesel |
| Transmission | Hydrostatic |
| Drive speed (max.) ⁽¹⁾ | 9 km/h (5.6 mph) |
| Aux. hydraulics oil flow | 50 l/min (13.2 GPM) |
| Max. lifting height | 2,92 m (115 in) |
| Tipping load, max. ⁽²⁾ | 1400 kg (3086 lbs) |
| Lifting capacity straight, max. ⁽³⁾ | 1120 kg (2469 lbs) |
| Breakout force / 50 cm | 1400 kg (3086 lbs) |
| Pushing force (c) | 1690 kgf (1690 kp) |
| Average ground pressure (w/standard tires) | 1022 kg/m ² (209 lbs/sqft) |
| Turning radius: inside/outside | 905/2020 mm (35.6/79.5 in) |
| Standard tires (Tractor profile) | 23X8.50-12 |
| Weight | 1400 kg (3090 lbs) |
| Product Code | C961015 |

⁽¹⁾ Maximum speed that can be achieved with the largest diameter tires available, on a flat surface and machine without attachments.

⁽²⁾ Tipping limit, when the machine is straight, with rear weights and boom lifted just off the ground. Weight of attachment included.

⁽³⁾ Maximum load that can be lifted just off the ground when the machine is straight and with rear weights. Weight of attachment is included.

Note: Refer to the Operator's manual for the comprehensive load diagram.

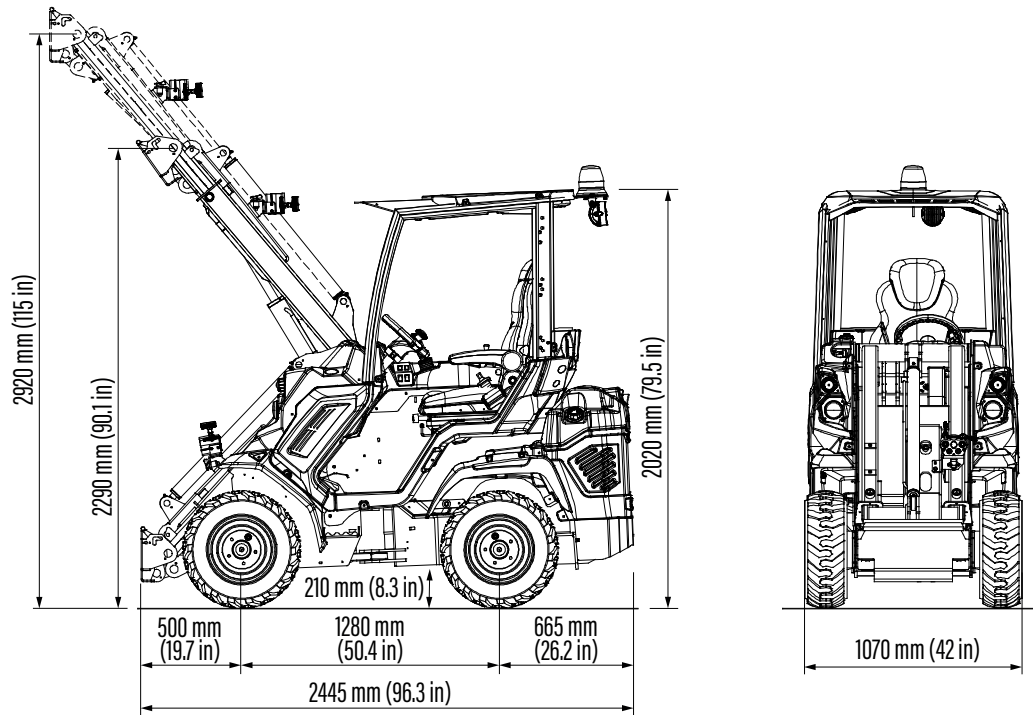

| Tires size | Height | Width |
|-------------------|-------------------|-------------------|
| 23X8.50-12 | 2020 mm (79.5 in) | 1070 mm (42 in) |
| 23X10.50-12 ET-25 | 2020 mm (79.5 in) | 1130 mm (44.5 in) |
| 26X12.00-12 ET-50 | 2040 mm (80.3 in) | 1280 mm (50.4 in) |
| 27X8.50-15 | 2080 mm (81.9 in) | 1070 mm (42 in) |
| 27X10.50-15 | 2080 mm (81.9 in) | 1150 mm (45.3 in) |

FEATURES

- Kubota D1305 (25 HP), big block, 3 cylinder, diesel engine, water cooled, electric start, glow plug
- Stage V and Tier 4 Final compliant engine
- Unbreakable Body Panels
- Hi-Flow system
- DBS (Dynamic Block System)
- ACI with Multi-functions joystick (22 functions)
- Hydraulically pilot operated variable displacement drive pump
- Self-levelling double-H telescopic boom
- Self-locking multi-disk parking brake
- Hydraulic oil cooler
- Hydraulic multiconnector
- Radial Piston high efficiency and heavy duty wheel motors
- 4WD hydrostatic Direct Drive motors, proportional servo control
- ROPS-FOPS Level I
- LCD graphic display with programmed service
- 2 front working light
- Ergonomic full adjustable suspension seated heated seat with armrests and seat belt

6 SERIES - OPTIONS

| Options | Code |
|---|---------|
| 110 V engine block heater | C885255 |
| 220 V engine block heater | C885250 |
| 2" Hitch receiver (not compatible with C883047) | C883062 |
| 3 additional working halogen light | C883064 |
| 3 additional working LED light | C883018 |
| Additional front hydraulic outlets | C883024 |
| Attachment coupling plate for rear mounting (not compatible with C883047) | C880031 |
| Automatic locking plate | C883038 |
| Backup warning beeper | C883021 |
| Beacon light | C883039 |
| Biodegradable oil | C883007 |
| Driver area cover | C880049 |
| Flat face coupling kit | C880221 |
| Floating boom valve | C883011 |
| Fully enclosed cab with sound insulation linen | C883001 |
| GPS tracker | C883075 |
| Heating system | C883072 |
| Left protection bar for operator | C883020 |
| Mirrors | C880081 |
| Polycarbonate back window (smart cabin) | C883035 |
| Polycarbonate right side (smart cabin) | C883034 |
| Polycarbonate windscreen (smart cabin) | C883000 |
| Rear 12V electric socket | C883022 |
| Rear bull bar (not compatible with C883062, C885014 and C880031) | C883047 |
| Rear hydraulic outlets - double | C883014 |
| Rear hydraulic outlets - single | C883013 |
| Rear side weights 80 kg (40 kg + 40 kg) / 176 lbs (88 lbs + 88 lbs) | C883078 |
| Rear side weights 160 kg (2x40 kg + 2x40 kg) / 352 lbs (2x88lbs+2x88lbs) | C883079 |
| Rear weights 180 kg (90 kg + 90 kg) / 396 lbs (198lbs + 198 lbs) | C880054 |

6 SERIES - OPTIONS

| Options | Code |
|--|---------|
| Skid tires 27x10.50-15, set of 4 | C884012 |
| Skid tires 27x8.50-15, set of 4 | C884011 |
| Snow chains for wheels 23x10.50-12, set of 2 | C880046 |
| Snow chains for wheels 23x8.50-12, set of 2 | C880041 |
| Snow chains for wheels 26x12.00-12, set of 2 | C880042 |
| Snow chains for wheels 27x8.50-15, set of 2 | C880045 |
| Tie down bracket on wheel hub, set of 4 | C883065 |
| Torque divider | C883600 |
| Tractor tires 23x10.50-12 ET-25, set of 4 | C884007 |
| Tractor tires 26x12.00-12 ET-50, set of 4 | C884009 |
| Trailer coupling (not compatible with C883047) | C885014 |
| Turf tires 23x10.50-12 ET-25, set of 4 | C884008 |
| Turf tires 23x8.50-12, set of 4 | C884006 |
| Turf tires 26x12.00-12 ET-50, set of 4 | C884010 |
| Warning & Safety lights for road travel (with mirrors) | C883009 |
| Wheel spacer 10 mm (0.4 in), set of 4 (max. 1 pcs for wheel) | C880090 |
| Wheel spacer 55 mm (2.2 in), set of 4 (max. 1 pcs for wheel) | C885010 |
| EU Certificate of Conformity (CoC) for road approval | COC |