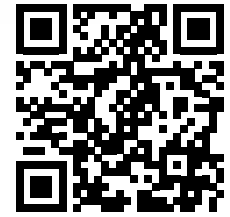
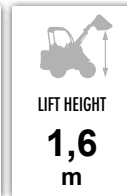
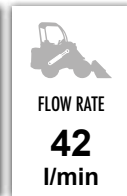
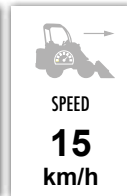
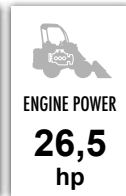
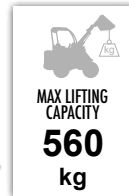

## 2 SERIES: 2.3 EFI

<http://tiny.cc/multione2-2EN>

**EFI**  
**ELECTRONIC  
FUEL  
INJECTION**

| Model  | 2.3 EFI                              |
|--|--------------------------------------|
| Engine   | Kohler EFI ECV749 - 2 cyl. - 747 cc  |
| Emission Standard                              | Stage V and EPA/CARB Phase III       |
| Power (Iso Gross) / Torque                     | 26,5 HP / 55,5 Nm @ 2600 rpm         |
| Fuel   | Petrol                               |
| Transmission                                   | Hydrostatic                          |
| Drive speed (max.) <sup>(1)</sup>              | 15 km/h (9.3 mph)                    |
| Aux. hydraulics oil flow                       | 42 l/min (11.1 GPM)                  |
| Max. lifting height                            | 1,6 m (63 in)                        |
| Tipping load, max. <sup>(2)</sup>              | 700 kg (1543 lbs)                    |
| Lifting capacity straight, max. <sup>(3)</sup> | 560 kg (1235 lbs)                    |
| Breakout force / 50 cm (19.7 in)               | 840 kg (1852 lbs)                    |
| Pushing force (c)                              | 770 kgf (770 kp)                     |
| Average ground pressure (w/standard tires)     | 583 kg/m <sup>2</sup> (119 lbs/sqft) |
| Turning radius: inside/outside                 | 700/1698 mm (27.6/66.9 in)           |
| Standard tires (Tractor profile)               | 20x8.00-10                           |
| Weight   | 710 kg (1570 lbs)                    |
| <b>Product Code</b>                            | <b>C951028</b>                       |

<sup>(1)</sup> Maximum speed that can be achieved with the largest diameter tires available, on a flat surface and machine without attachments.

<sup>(2)</sup> Tipping limit, when the machine is straight, with rear weights and boom lifted just off the ground. Weight of attachment included.

<sup>(3)</sup> Maximum load that can be lifted just off the ground when the machine is straight and with rear weights. Weight of attachment is included.

Note: Refer to the Operator's manual for the comprehensive load diagram.

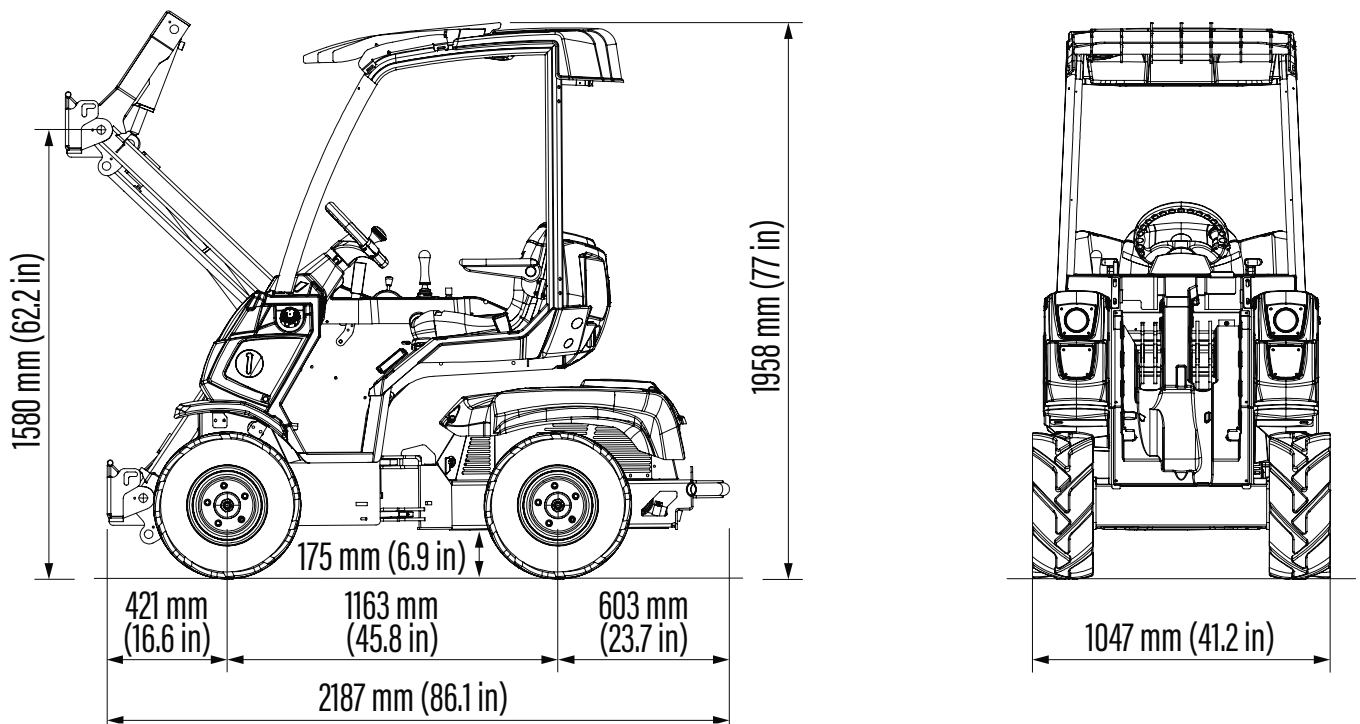

| Tires size | Height            | Width             |
|------------|-------------------|-------------------|
| 20x8.00-10 | 1958 mm (77 in)   | 1047 mm (41.2 in) |
| 23x8.50-12 | 1996 mm (78.6 in) | 1060 mm (41.7 in) |

## FEATURES

- Kohler Command Pro EFI ECV749, 2 cylinder, 747 cc. petrol engine, air cooled, electric start, with electronic fuel injection (EFI)
- Stage V and EPA/CARB Phase III compliant engine
- DBS (Dynamic Block System)
- Hydraulic oil cooler
- Self-levelling H-frame boom
- Hydraulic multiconnector
- 4-functions joystick
- Hour meter, fuel gauge, engine MIL
- 4WD hydrostatic Direct Drive motors, proportional servo control
- Hydraulically pilot operated variable displacement drive pump
- ROPS-FOPS Level I
- 2 front working light
- Ergonomic heated seat with armrests and seat belt, adjustable position
- Mechanical parking brake
- High efficiency wheel motors

## 2 SERIES - OPTIONS

| Options   | Code    |
|---|---------|
| 3 additional working halogen light  | C883064 |
| 3 additional working LED light  | C883018 |
| Backup warning beeper   | C883021 |
| Beacon light  | C883039 |
| Biodegradable oil   | C883200 |
| Driver area cover   | C880049 |
| Flat face coupling kit  | C880221 |
| Fully enclosed cab with heating system  | C885224 |
| GPS tracker   | C883075 |
| Kohler Bluetooth diagnostic interface kit<br>(compatible with Android or iOS diagnostic applications) | C883201 |
| Left protection bar for operator  | C885027 |
| Mirrors   | C880081 |
| Polycarbonate back window (smart cabin)   | C885239 |
| Polycarbonate right side (smart cabin)  | C885238 |
| Polycarbonate windscreen (smart cabin)  | C885237 |
| Rear weights 180 kg (90 kg + 90 kg) / 396 lbs (198lbs + 198 lbs)                                      | C880054 |
| Snow chains for wheels 20x8.00-10, set of 2   | C880040 |
| Tie down bracket on wheel hub, set of 4   | C883068 |
| Torque divider  | C883600 |
| Tractor tires 23x8.50-12, set of 4  | C884005 |
| Trailer coupling  | C885014 |
| Turf profile tires 20x8.00-10, set of 4   | C885211 |
| Turf tires 23x8.50-12, set of 4   | C884006 |
| Warning & Safety lights for road travel (with mirrors)  | C885240 |
| Wheel spacer 10 mm (0,4 in), set of 4 (max. 2 pcs for wheel)  | C880090 |
| Wheel spacer 55 mm (2,2 in), set of 4 (max. 1 pcs for wheel)  | C885010 |
| ACI Upgrade   | C090027 |